

Rev.			
Modify			
Date			
Signed			
Approved			

Rev.			
Modify			
Date			
Signed			
Approved			

Rev.			
Modify			
Date			
Signed			
Approved			

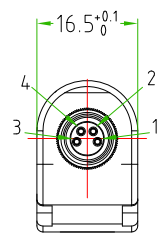
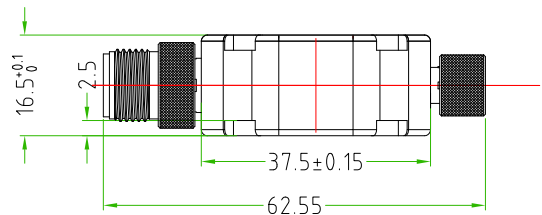
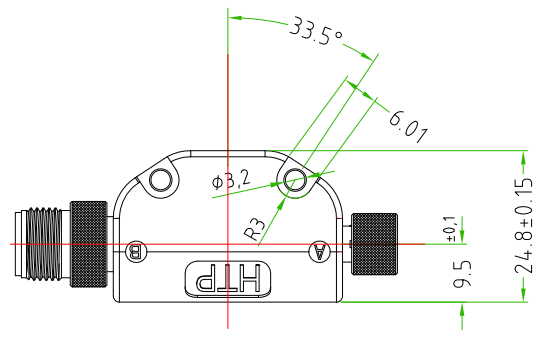
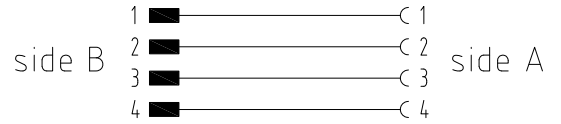

side A

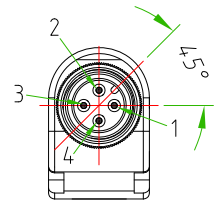
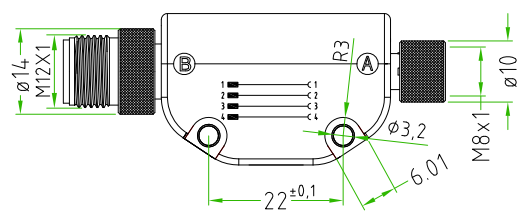

side B

CUSTOMER APPROVAL

SIGNATURE	DATE

PLEASE SIGN AND RETURN

CONNECTOR FEATURES	PRODUCT TYPE	M8-M12 ADAPTOR
	CONTACTS TYPE	SIDE A: M8 FEMALE 4POLES SIDE B: M12 MALE 4POLES
	HOUSING MATERIAL	POLYPROPYLENE
	COLOUR	BLACK
	COUPLING NUT MATERIAL	BRASS+NICKEL PLATED
	NUMBER OF CONTACTS CONNECTED	N°4
	CIRCUIT TYPE	PARALLEL
	RATED VOLTAGE	50V AC/ 60V DC
	RATED CURRENT	3A
	FIXING HOLES DIAMETER(x2)	ø3,2
FIXING HOLES DISTANCE	22mm	
PRODUCT WITH H.T.P.LOGO		
PAY ATTENTION TO ALL THE POLARIZATION KEYS POSITIONING OF EACH CONNECTOR.		

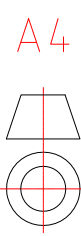

Designer	SUGLIANI R.	Date	2016-10-19	Tolerance	±0.3	Units:	mm	Series	M8-M12 ADAPTOR	Drawing n.	1-1
Approved	CIMMINO L.	Date	2016-10-19	Scale	1:1	Size:	A4	Customer code:			

	<p style="color: red; font-weight: bold;">DESCRIPTION</p> M8-M12 ADAPTOR CONNECTOR, BLACK, PARALLEL CIRCUIT, WITH N°2 CONNECTORS: M8 FEMALE 4POLES(SIDE A)+M12 MALE 4POLES(SIDE B) CONNECTOR WITH H.T.P.LOGO	<p style="color: red; font-weight: bold;">H.T.P.PART NUMBER</p> <div style="border: 1px solid black; padding: 5px; display: inline-block;"> <p style="margin: 0;">08FD4-12MD4</p> </div>
--	--	--