

Rev.	Modify	Date	Firma	Approved

Rev.	Modify	Date	Firma	Approved

Rev.	Modify	Date	Signed	Approved
01	-	2017.07.18	SUGLIANI CIMMINO	

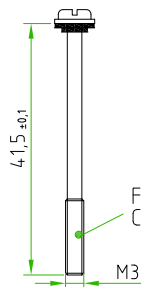
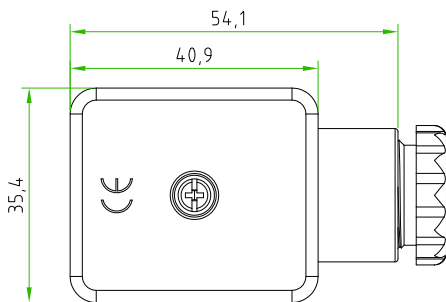
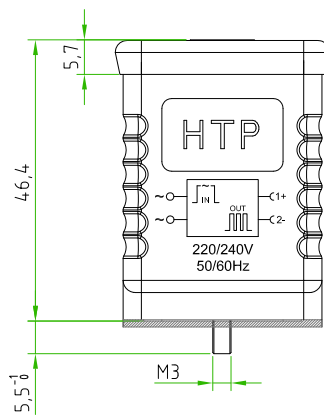
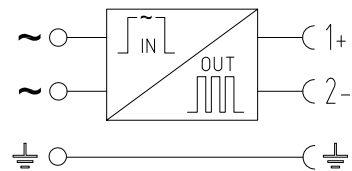
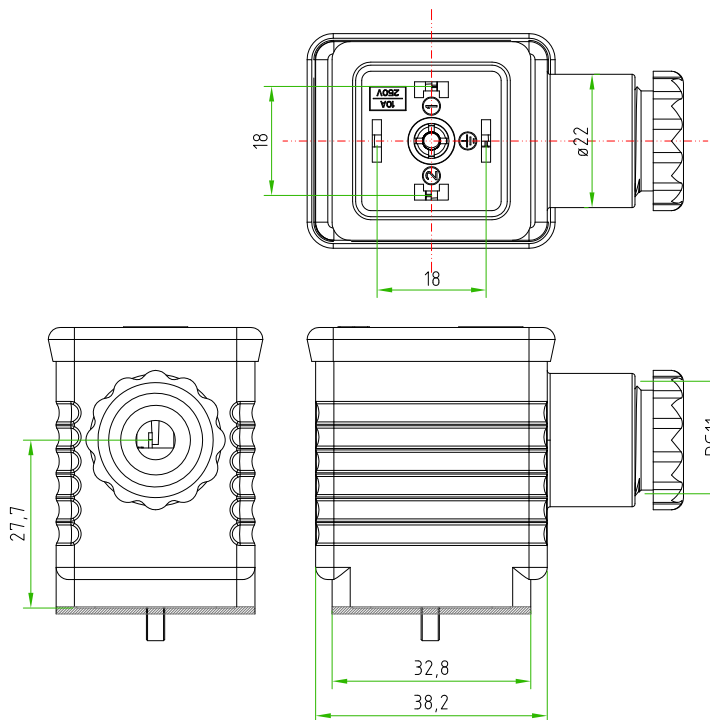

FIXING SCREW COMPLETE OF O-RING  
CODE:10001500F

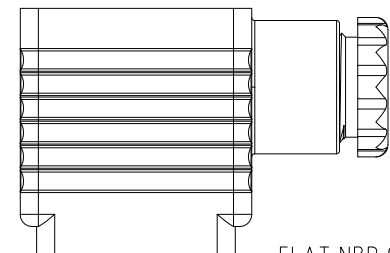
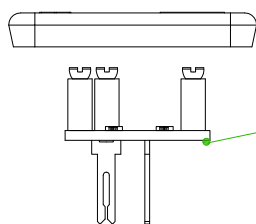

FLAT NBR GASKET  
CODE:10001400A

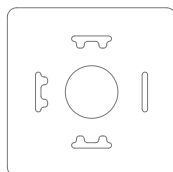

CONNECTOR FEATURES	
PRODUCT TYPE	EN175301-803 INDUSTRY STANDARD FORM A, FIELD ATTACHABLE
HOUSING COLOUR	BLACK
COVER COLOUR	BLACK
PRESS-CABLE COLOUR	BLACK
HEIGHT HOUSING	46,4mm
CONTACTS SPACING	18mm
CONTACTS TYPE	SCREW CONTACTS
NUMBER OF POLES	2POLES+EARTH
EARTH POSITIONING	H.12 (TURNABLE)
CABLE EXIT	PG9/11 UNIFIED
SUITABLE CABLE	FROM ø6mm TO ø10mm
PROTECTION CLASS	IP65
CIRCUIT TYPE	WITH ENERGY SAVING CUSTOMIZED
RATED VOLTAGE	220/240V AC ±10%
TIME BOOST	180ms
POWER MAINTENANCE	50% POWER MAX.
NOMINAL POWER	10W
MAX.POWER	90VA
GASKET TYPE	FLAT NBR (CODE:10001400A)
FIXING SCREW	M3X0,5 L=4,15mm (CODE:10001500F)
CONNECTOR TEMPERATURE RANGE	from -20°C to +70°C
MAX.CONDUCTOR SIZE	1,5mm <sup>2</sup>
CONNECTOR WITH H.T.P. LOGO	
PAY ATTENTION: CONNECTOR SUITABLE ONLY WITH RAC COILS <b>REV.01</b>	

CUSTOMER APPROVAL

SIGNATURE      DATE

PLEASE SIGN  
AND RETURN

A4

Designer	SUGLIANI R.	Date	2017-06-09	Tolerance	±0,2	Units:	mm	Series	EN175301-803 (form A)	Drawing n.	1/3
Approved	CIMMINO L.	Date	2017-06-09	Scale	TO FIT	Size:	A4	Customer code:			

DESCRIPTION

SQUARE CONNECTOR EN175301-803 FORM A, FIELD ATTACHABLE, 2P.+PE, WITH ENERGY SAVING CIRCUIT(CUSTOM), 220/240V, PG9/11 unified, BLACK HOUSING, CONNECTOR WITH H.T.P. LOGO

H.T.P.PART NUMBER

G4NU2ES3

